

Gas Insulated Ring Main Unit

RVAC

Professional solutions ,
Reliable power



EATON

Powering Business Worldwide



Automotive



Aerospace



Truck



Hydraulics



Electrical

Powering business worldwide

Eaton delivers the power inside hundreds of products that are answering the demands of today's fast changing world.

We help our customers worldwide manage the power they need for buildings, aircraft, trucks, cars, machinery and entire businesses. And we do it in a way that consumes fewer resources.

Next generation transportation

Eaton is driving the development of new technologies – from hybrid drivetrains and emission control systems to advanced engine components – that reduce fuel consumption and emissions in trucks and cars.

Higher expectations

We continue to expand our aerospace solutions and services to meet the needs of new aviation platforms, including the high-flying light jet and very light jet markets.

Building on our strengths

Our hydraulics business combines localised service and support with an innovative portfolio of fluid power solutions to answer the needs of global infrastructure projects, including locks, canals and dams.

Powering Greener Buildings and Businesses

Eaton's Electrical Group is a leading provider of power quality, distribution and control solutions that increase energy efficiency and improve power quality, safety and reliability. Our solutions offer a growing portfolio of "green" products and services, such as energy audits and real-time energy consumption monitoring. Eaton's Uninterruptible Power Supplies (UPS), variable-speed drives and lighting controls help conserve energy and increase efficiency.

RVAC

Ring Main Unit

The development of current power system focuses on the usage of ecological resources. Low power loss, low maintenance spending, reliable performance, flexible configuration are required on the medium voltage switchgear. Due to its features such as long service life, compact size and recycling, Eaton RVAC ring main units have proved successful in terms of economy and ecology. It appears more important for Underground cabled power distribution network in improving its devices and other aspects, with rapid development of urbanization; ring main units (RMU), as the major device for protection and segment isolation to ground cabled distribution network, are widely used in urban power grids, due to its safe and reliable performance, compact and superior cost effectiveness.

Eaton as the leader in the field of distribution switchgear has Lean to designing and manufacture high-quality power distribution switchgear since 1942, with over 2 million switchgear operating reliably over the world till now.



Based on the design concept of full insulation and fully sealed, all primary parts within RVAC RMU are fully sealed inside the stainless-steel main enclosure, protect to against condensation and external contaminated environment; the protection degree of the main tank body is up to IP67, equipped with Cooper's water-proofing touchable cable bond, which can provide effective protection against accidental flood in rainy climate.



RVAC Ring Main Unit Construction Feature

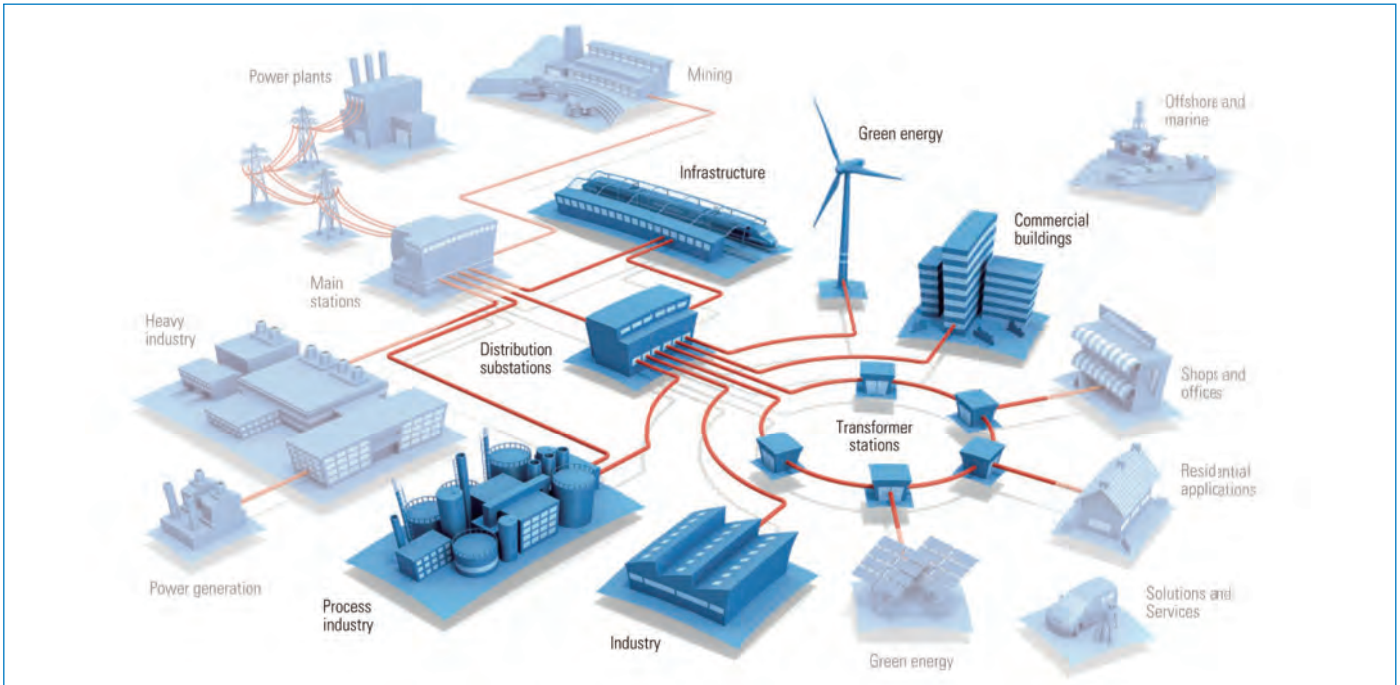

Smart grid readiness

Designed to integrate solutions for sensing, monitoring and remote control for feeder automation and load management purposes.

Personal safety

- Logical mechanical and electrical interlocks;
- Complete enclosure earthing, to ensure zero potential for interface;
- Compartments protected against penetration of objects;
- Capacitive voltage detection system for verification of safe isolation from supply;
- Feeder earthing by means of make-proof earthing switch.

Environmental-friendly concept

- Low power loss, low maintenance spending, ensuring more reasonable cost investment;
- Only reusable and/or recyclable materials can be used to do the most compact design;
- In normal working conditions, gas leakage rate of lower than 1‰ ensures more than 30 years life-cycle;
- Without gas work on site through installation, operation, extension, and replacement of the product.

User friendly

- Cable connection and user interfaces for operation on the same front side of the panel;
- Ergonomic cable connection height;
- A customized low voltage compartment is optional;
- Clear and simple straightforward operation panels.

Modular design and flexible configuration

- Both multi-functions in one tank solution and individual panel can be freely combined and extended, to satisfy demands of different customers;
- Non-extensible and both side extensible design suit for your requirements.
- Flexible extension of unit modules on site, easy to build medium voltage transformer substations according to different requirements;
- Two options are available for transformer and line protections: load break switch-fuse combination units and circuit breakers with relay protection.

All-weather and high adaptability to environment

- SF6 gas tank is made of stainless steel plates, with anti-rust painting treatment on the surface, to protect against salt spray, humidity, dirt and temperature, and to ensure durable nice appearance;
- COOPER pre-fabricated shielding touchable cable terminal is supplied, suitable for long-term operation underwater or in other severe conditions.

Operation

- Complete design certified in accordance with GB / DL and IEC standards;
- Arc fault tested according GB3906 / IEC 62271-200;
- Quality assurance in accordance with ISO 9001;
- Touching safe and hermetically sealed primary enclosure;
- Gas tank's zero gauge voltage withstand (1min) can reach power frequency withstand voltage.

Main Construction

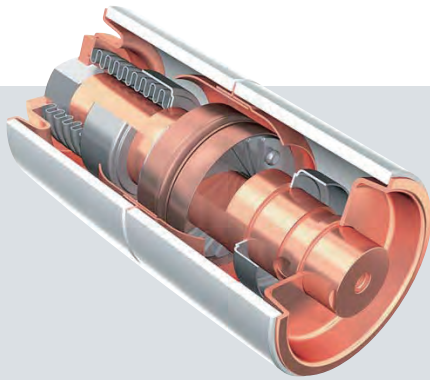

Vacuum technology features

- Eaton has an unsurpassed leadership in vacuum technology supported by a strong heritage of innovation from companies such as Westinghouse and Holec
- Pioneers in vacuum technology for over 90 years. First vacuum interrupter supplied at 15kV-12kA in 1967
- Eaton was the first one to develop and patent copper-chromium alloy content for contacts and center shields
- Our vacuum interrupters for contactor applications can perform up to 2.5 million mechanical operations
- More than 5 million units delivered worldwide, operating safely and reliably in all types of networks, medium voltage applications and environments
- High end certified supplier to almost all major electrical manufacturers worldwide



SF6 gas insulated system

- All primary high-voltage components are completely enclosed in SF6 gas tank, free from environment impact, thus ensuring fully insulation and maintenance-free;
- SF6 gas tank is made of high-quality stainless steel materials, free from influence of salt spray, humidity, dirt and temperature, ensuring a durable nice outlook;
- With IP67 protection degree, can reliably prevent from flood immersion in summer;
- Advance gas shielded welding as well as a sealing pressure system of less than 1% leakage rate ensure a 30 year service cycle;
- Non-extensible is standard busbar extensible is optional.



Load break switch

The load break switch is a 3-position switch, with Close, Open and earthing position. When in Open position, the moving blade has sufficient insulation distance. An operating handle can be used to make close-open operations on load break switch and earthing switch. There are mechanical interlocks between the load break switch and the earthing switch.

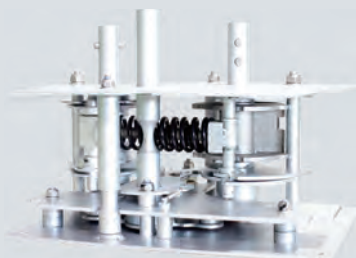

- The load break switch applies metal deionizing arc suppress technology, ensuring good interruption performance for the switch;
- The working speed of switch's moving contact depends on its operation mechanism; and the open-close speed of the switch will not be influenced by operators;
- When moving from closing to opening, the load break switch depends on moving contact speed and arc suppress devices simultaneously, to suppress arc and break current;
- The spring operation mechanism with an operating handle to complete closing and opening operations. Motorization module and opening coil can be added, to achieve remote control.

Product Features

RVAC is developed to be an economical and ecological user-friendly power distribution device of compact size, reliable performance and flexible configuration, with the application of advanced R&D technical resources.

Computer simulation design

3D simulation design analysis softwares are applied during R&D process, strengthening design capacity, and thus improving product reliability greatly.

Mechanical movement analysis and force analysis



Mechanical strength analysis

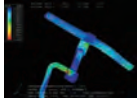

Gas pressure analysis

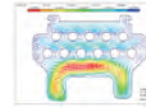
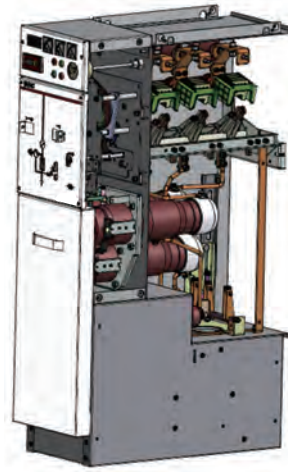
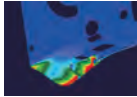

Magnetic field analysis

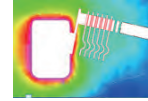

Electric field analysis

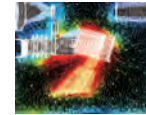

Gas motion analysis

Capacitive voltage detection system for verification of safe isolation from supply

Each panel type within the RVAC family is equipped with a standard three phase Voltage Detection System for voltage testing. The VDS shows the operator if the panel is isolated from supply or not.

Logical mechanical and electrical interlocks prevent incorrect operation

Within the RVAC design misoperation by an operator is prevented by using different interlocks. The interlocks are mechanical and electrical. For example electrical and mechanical interlocks prevent operation of the change-over switch when the circuit-breaker is switched on. All mechanical interlocks are constructed in such a way that they directly block the mechanism.

Only when the cable compartment door is closed, the device can be operated to power-on position

Only when the switch is operated to Earthing position, the cable compartment door can be opened in a normal way. Only when the cable compartment door is closed completely, a closing operation can be conducted on the earthing switch. After the earthing switch is opened, the mains switch can conduct closing operation to complete power-on process.

Sealed enclosure design, to effectively protect against foreign objects

In the design of RVAC, it is not possible for external staff or tools to accidentally enter into the panel.

Smooth contemporary design

All compartments of the RVAC panels are designed in such a way that the system is safe to touch from the outside. By using a smooth and smart design it is not possible for the operator to injure himself by moving parts or by parts that stick out of the switchgear when moving in front of the switchgear.

Routine tests

Various prescribed routine tests are carried out during the production of the switchgear. To assure quality, all processes are in accordance with ISO 9001. This means that at every stage of production the components, circuit-breakers and current transformers are inspected for correct functionality. When the entire installation has been assembled, a thorough visual inspection is carried out, together with mechanical, functional and electrical checks.

Anti-internal arcing concept

Eaton has always been focusing on building consistently safe switchgear devices for operators. The biggest potential risk for operators is internal arcing within the switchgear device.

Therefore, design engineers have taken all necessary measures to prevent internal arcing during product design process.

Eaton supports the philosophy that it is best to avoid internal arcs than to cure, in line with the relevant standard GB 3906, IEC 62271. Within the RVAC design a double prevention philosophy is used. Firstly, the design is constructed in such a way that an internal arc is prevented. In the unlikely case that an internal arc could occur, the RVAC is equipped to provide maximum safety to the operator, and to control and minimise damage to the rest of the switchgear and room.

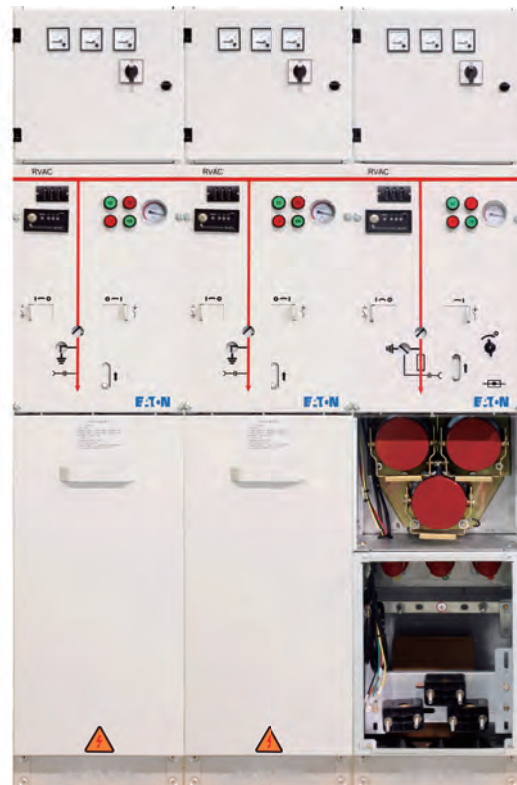

Sulfur Hexafluoride (SF6) Gas

The insulating and arc quenching medium -SF6

SF6 gas, previously used mainly in circuit breaker of higher voltage level and with successful achievements, has now been found into medium voltage load switching system in recent years. This change happens to systems all over the world, since each insulation and arc-extinguishing medium, including air, oil and solid material, has its own critical defect more or less:

- Air insulation system occupies a large amount of space, which requires maintenance in extreme climate or environment;
- Oil insulation system will cause huge safety risks due to internal faults, although not influenced by external environment;
- Finally, solid system has the same maintenance issue as air insulated devices do, but with problems to a higher level due to its compact structure.

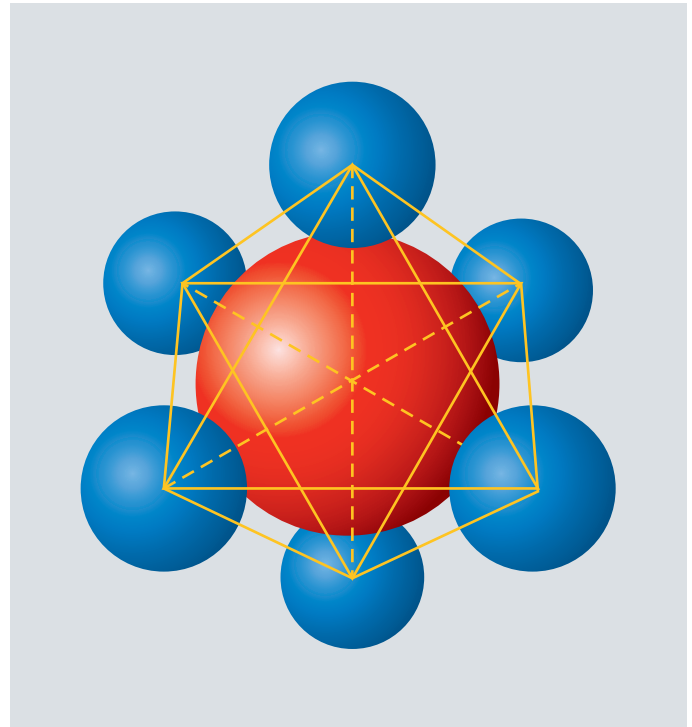

SF6 is a non-toxic, inert and electronegative gas, heavier than air, offering very effective arc-extinguishing performance, along with the above-mentioned high insulation capability. In the case of high temperature arc produced by circuit breaking, SF6 gas will resolve into subfluorides. After cooling down, these active subfluorides will quickly return back to SF6 gas. Therefore, SF6 gas which is used under sealing for a long time will not decrease or deteriorate, although under the effect of arc extinguishing several times. The amount of arc decomposition depends on water content contained in SF6 gas. In this way, it is very critical to control water content below specified values. Adsorbing agents such as commonly used activated alumina or activated carbon and synthetic zeolite remove water and arcing products, which means the volume of the gas originally introduced keeps unchanged and can satisfy requirements for working life or mechanism of the whole system. An evaluation of advantage and potential risks shows that at present there is no substitutable solution of technical and ecological values.

SF6 gas has very high dielectric strength as an insulation medium, thus offering very compact products in the design of structural arrangement, and maintenance free since all live parts are completely sealed.

Final disposal of SF6 gas

1. The policy of Eaton is that SF6 gas shall be inhibited to emit into air during the process of installation, maintenance and scrapping of devices. Environmental solutions can be used to dispose SF6 gas which can't be recycled or reused any more, which produce natural product gypsum (CaSO4) and fluorite (CaF2).
2. For more details, refer to IEC's technical report 1634 (1995): High Voltage Switchgear and Controlgear - Usage and Disposal of SF6 in High Voltage Switchgear and Controlgear Devices, Chapter 6.5: " Disposal of SF6 at life end- refilling devices."



Features and benefits

The benefit of a sealed for life tank

A "sealed for life" steel enclosure contains all primary parts and driving mechanisms

- Maintenance free
- Internal arc proof
- Protection degree up to IP67 for prevention of summer floods

The benefit of a compact design

- Minimal floor space
- Low building costs
- Easy to install

Computer simulation design

3D simulation design analysis softwares are applied during R&D process to strengthen design capacity, thus improving product reliability greatly.

- Electric field analysis
- Magnetic field analysis
- Gas pressure and motion analysis
- Mechanical strength analysis
- Mechanical movement (speed and force) analysis
- Finite element analysis

Smart grid readiness

Automation upgrading

- Remote close/open
- Auxiliary contacts for each position local or remote indications
- Measuring CT and current signal

Option

- Trip indicator with auxiliary contacts
- Fault indicator
- Current meter

Flexible solutions

- Reliable busbar extended design and interfaces reserved for future project expansion
- Complete types of functional units

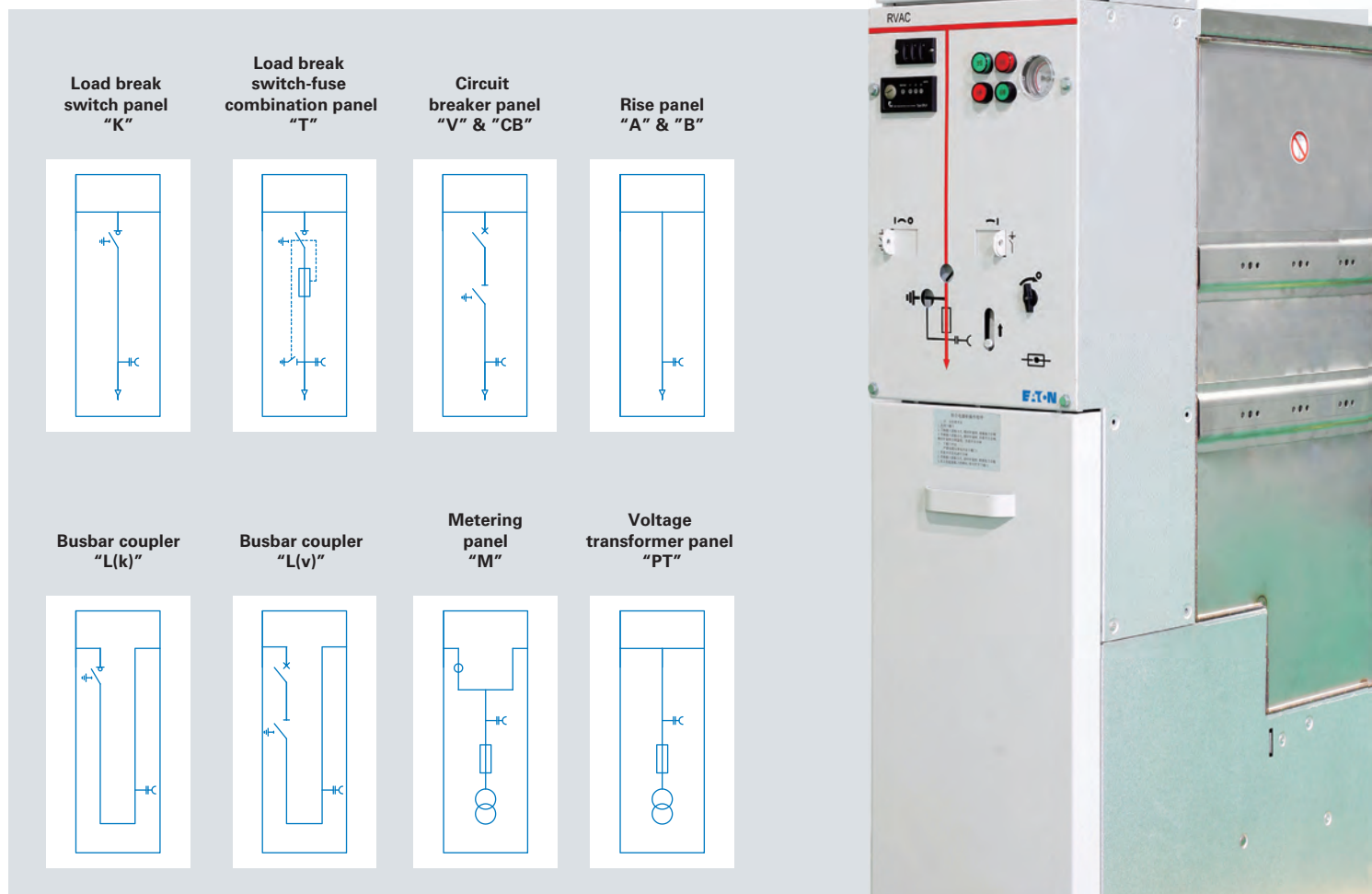

Configuration information

Load break switch panel (Function K)



Standard

- 630A load break switch
- SF6 pressure gauge
- Voltage presence indicator
- Reliable interlock
- Operating handle
- Cable clamp and bracket

Options

- Extension on both sides
- Lateral incoming and outgoing
- Motorization mechanism
- Bottom plate
- Cable inspection window
- Short circuit fault indicator
- Earthing switch

Rated voltage (kV)	W (mm)	D (mm)	H (mm)	Weight (kg)
24	370	870	1400	132

Lift panel (Function A/B)



Note: A without gas tank; B with gas tank

Standard

- Voltage presence indicator
- 630A bushing
- Padlock for cable compartment cover
- SF6 pressure gauge
- Voltage presence indicator
- Operating handle
- Cable clamp and bracket

Options

- Extension on both sides
- Lateral incoming and outgoing
- Cable inspection window
- Short circuit fault indicator
- Current meter
- Bottom plate

Rated voltage (kV)	W (mm)	D (mm)	H (mm)	Weight (kg)
24	370	870	1400	110

Load break switch-fuse combination panel (Function T)



Standard

- 630A load break switch
- Earth switch
- Fuse tube
- SF6 pressure gauge
- Voltage presence indicator
- Reliable interlock
- Operating handle
- Cable clamp and bracket

Options

- Extension on both sides
- Lateral incoming and outgoing
- Motorization mechanism
- Electric shunt release
- Bottom plate
- Cable inspection window
- Short circuit fault indicator
- Fuse adapter *

* Adapter must be applied together with 12kV Fuse when the system rated voltage is 12kV.

Rated voltage (kV)	W (mm)	D (mm)	H (mm)	Weight (kg)
24	370	870	1400	170

The fuse dimension

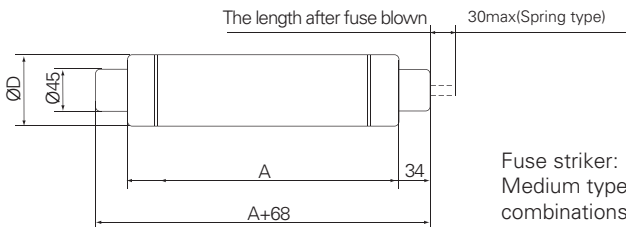

Fuse striker:
Medium type (according IEC 60282-1, DIN and GB 15166.2, alternating current switch-fuse combinations).

The guide for fuse selection

General type	Rated voltage (kV)	Rated fuse current (A)	Length A (mm)	Diameter D (mm)
XRN-T/12	12	3.15 / 6.3 / 7.5 / 10 / 16 / 20 / 25 / 31.5 / 40	292	51
		50 / 63 / 80	292	66
		100 / 125	292	76
XRT1-24	24	3.15 / 6.3 / 7.5 / 10	442	51
		16 / 20 / 25 / 31.5	442	66
		40 / 50 / 63 / 80	442	76

Fuse selection and transformer application

Rated voltage (12kV)

Transformer rated capacity (kVA)	50	100	125	160	200	250	315	400	500	630	800	1000	1250
Fuse rated current (A)	6.3	10	16	16	20	25	32	40	50	63	80	100	125

Rated voltage (24kV)

Transformer rated capacity (kVA)	≤ 40	100	125	160	200	250	315	400	500	630	800	1000	1250
Fuse rated current (A)	3.15	6.3	10	10	16	16	20	25	31.5	40	50	63	80

Circuit breaker panel (Function V)



Standard

- 630A vacuum breaker
- 3-position disconnecter
- SF6 pressure gauge
- Voltage presence indicator
- Reliable interlock
- Operating handle
- Cable clamp and bracket

Options

- Extension on both sides
- Lateral incoming and outgoing
- Motorization mechanism
- Two cable outgoing lines
- Cable inspection window
- Short circuit fault indicator
- Protection relay

Rated voltage (kV)	W (mm)	D (mm)	H (mm)	Weight (kg)
24	520	870	1400	250

Busbar coupling panel (Function L)



Standard

- 630A load break switch
- SF6 pressure gauge
- Voltage presence indicator

Options

- Motorization mechanism
- Cable inspection window

Load-break-switch type L(k);

Rated voltage (kV)	W (mm)	D (mm)	H (mm)	Weight (kg)
24	480	870	1400	150

Busbar coupling panel (Function L)

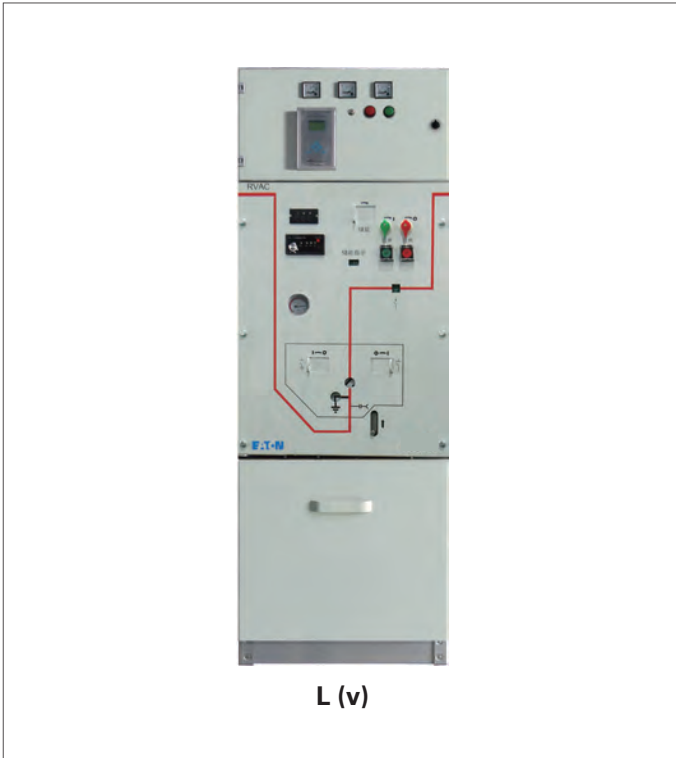

Standard

630A vacuum breaker
 3-position disconnect
 SF6 pressure gauge
 Voltage presence indicator

Options

Motorization mechanism
 Cable inspection window
 Protection relay

Circuit-breaker type L(V)

Rated voltage (kV)	W (mm)	D (mm)	H (mm)	Weight (kg)
24	600	870	1400	275

Metering panel (Function M) / Voltage transformer panel (Function PT)

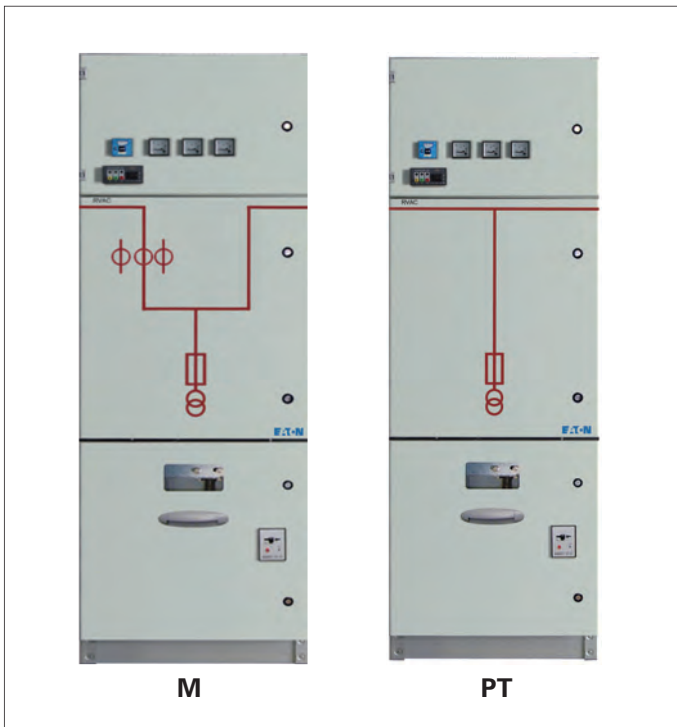

Standard

Electromagnetic lock (with live latch)
 PT
 PT protection fuse
 CT
 Meter
 Voltage presence indicator
 Voltage meter
 Current meter
 Transfer switch

Options

Energy meter
 Voltage loss meter
 Temperature and humidity controller

Function M

Rated voltage (kV)	W (mm)	D (mm)	H (mm)	Weight (kg)
24	800	1050	1500	260

Function PT

Rated voltage (kV)	W (mm)	D (mm)	H (mm)	Weight (kg)
24	520	870	1400	200

PBD protection relay



- 3-phase 3-step directional current protection (quick break, timed quick break, over-current inverse time), with low voltage locking function
- 3-phase 3-time reclosing (inspection for no voltage, inspection for synchronization, no inspection), the number of reclosing operations can be set, including the function of post-acceleration
- Zero sequence voltage locking direction zero sequence over current protection (alarm, optional tripping operation)
- Low current grounding line selection function
- Low voltage protection
- Overload alarm
- 24V DC

PSW Self-powered protection device

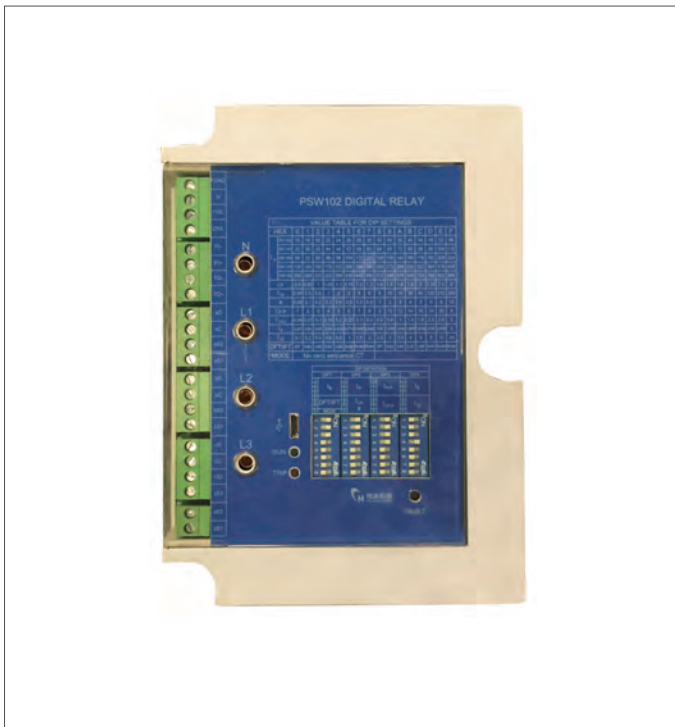

The PSW Self-powered protection device is a kind of protection device for 10 kV feeder lines which has over current, instantaneous trip and ground protection functions. This product can be used in conjunction with the ONT-W series current transformers (CT), and the power is supplied from line current through CT, so over current, instantaneous trip and ground protection for distribution network lines could be achieved without auxiliary power supplies by driving low power trip coils.

PSW 100 Function:

- Definite time over current protection (ANSI 50/51)
- Definite time instantaneous trip protection (ANSI 50/51)
- Inverse time over current protection (ANSI 50/51)
- Definite time single phase to ground protection (ANSI 50N/51N)

Main Components

Voltage indicator

A device on all functional units makes it possible to check the presence(or absence) of voltage in the cables. With the holes for phase comparators.



Voltage indicator

Fault indicator

The indicator is used for detecting and indicating ground fault and short-circuit fault in corresponding cable sections. The indicator light flashes with alarm when short-circuit fault or single-phase ground fault occurs in the power distribution system.



Fault indicator

Copper Screened Separable Connectors

For connection of extruded polymeric cable to transformers, switchgear, motors and other equipment with a premolded screened separable connectors for XLPE insulated 1 or 3-core cabled with aluminum or copper conductors.



Connection mode

Extension interface

For future extension connected to another module RVAC.

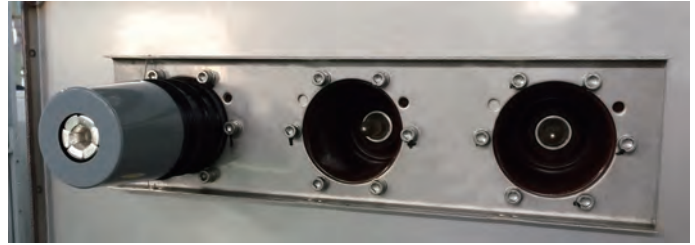

Busbar Linker

Connected existing module RVAC with another module RVAC.



Busbar ender stop

When the cabinet is reserved for future expansion on Extension interface, and the busbar linker is not installed, you need to use Busbar ender stop to protect the main busbar bushing.



Insulation cap

When the cabinet is reserved busbar bushing for transformer on the main busbar side, and the cable plug is not installed, you need to use Insulation cap to protect the busbar bushing.



Fuse adapter

The adapter must be configured together with fuse when the product is used in 12kV system.



RVAC Technical Data

Item		Ratings
General		
Rated voltage	kV	24
Power frequency withstand voltage (1min)		
Phase to phase/Phase to earth	kV	50
Between isolating distance		60
Lightning impulse withstand voltage (BIL)		
Phase to phase/Phase to earth	kV	125
Between isolating distance		145
Rated frequency	Hz	50
Internal arc classification (IAC)	kA-s	AFLR 20-1
Degree of protection in service		IP3X
Degree of protection with doors/covers open		IP2X
Service continuity of the switchgear		LSC2
Application environment condition	Humidity	≤ 100%
	Temperature	-25°C ~ +50°C
Busbar system		
Rated normal current	A	630
Rated short-time withstand current	kA-s	20-3
Rated peak withstand current	kA	50
Load break switches panel		
Rated normal current	A	630
Rated short-circuit making current	kA	50
Rated short-time withstand current	kA-s	20-3
Mechanical endurance class (Load break switch)		M1 5000
Mechanical endurance class (Earthing switch)		M1 2000
Electrical endurance class (active load breaking capacity 630A)		E3
Cable-charging breaking capacity	A	40 (24kV, 10CO)
Circuit-breakers panel		
Rated normal current	A	630
Rated breaking current	kA	20
Rated short-circuit making current	kA	50
Rated capacitive switching current class		C2
Mechanical endurance class (Circuit-breakers)		M1 2000
Mechanical endurance class (Earthing switch)		M1 2000
Electrical endurance class		E2
Rated short-time withstand current	kA-s	20-3
Mechanism type		0 - 0.3s - CO - 180s - CO
Switch-fuse combination panel		
Normal current of load-break switch	A	630
Normal current with fuses	A	80
Rated breaking current	kA	31.5
Rated short-circuit making current	kA	80
Rated transfer current	A	900

For others, please contact local Eaton sales representative.

RVAC designed to IEC standards

RVAC complies with the following standards

IEC62271-1	Common specifications for high-voltage switchgear and controlgear
IEC62271-103	High-voltage switches for rated voltages above 1kV up to and including 52 kV
IEC62271-102	High-voltage alternating current disconnectors and earthing switches
IEC62271-200	A.C. metal-enclosed switchgear and controlgear for rated voltages above 1kV and up to including 52kV
IEC62271-100	High-voltage alternating-current circuit breakers
IEC62271-105	High-voltage alternating current switch-fuse combinations for rated voltage above 1kV up to and including 52kV

RVAC Outlines and Dimensions

Type K panel dimension

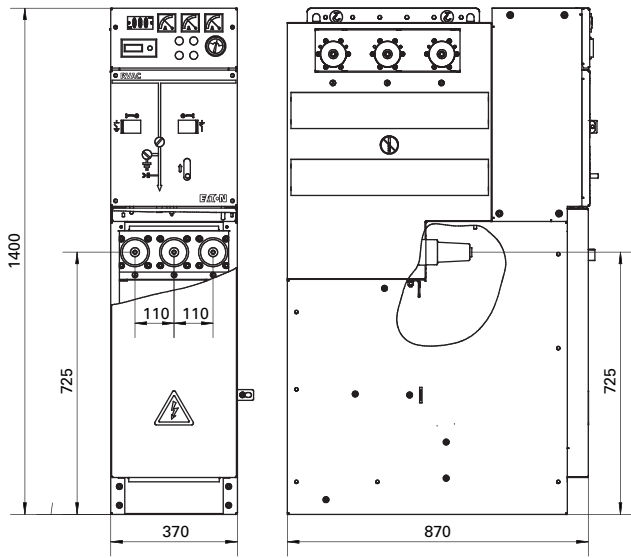

Type T panel dimension

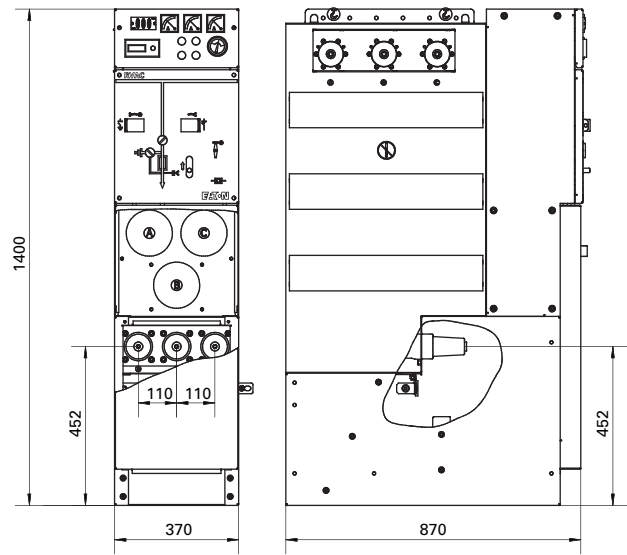

Type V panel dimension

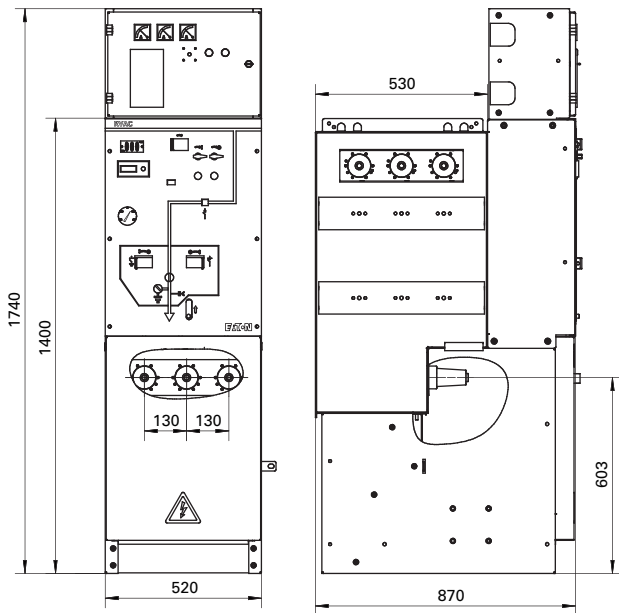

Type M panel dimension

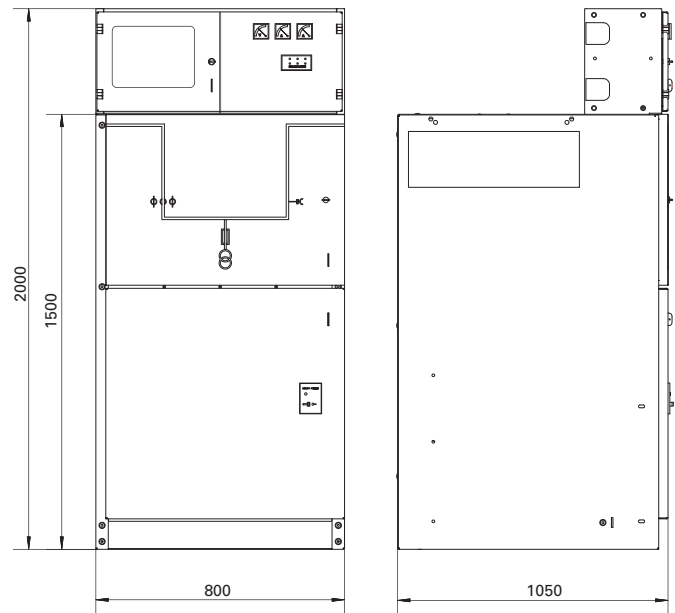

Basic Installation Diagram

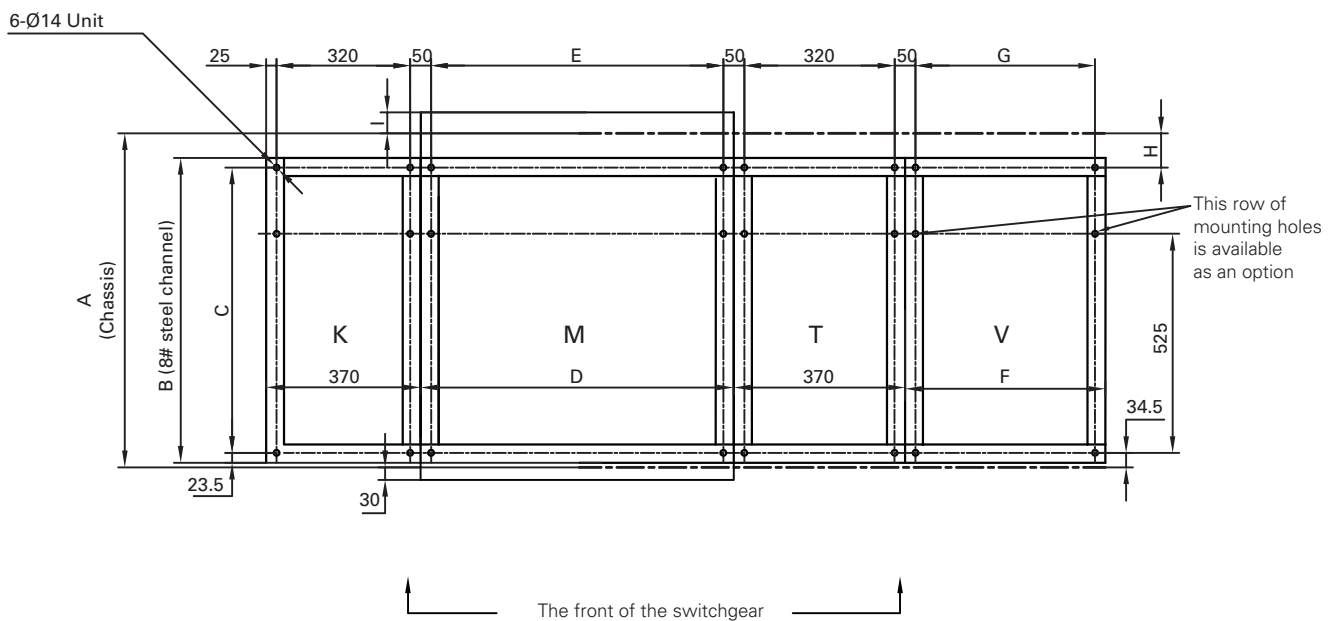
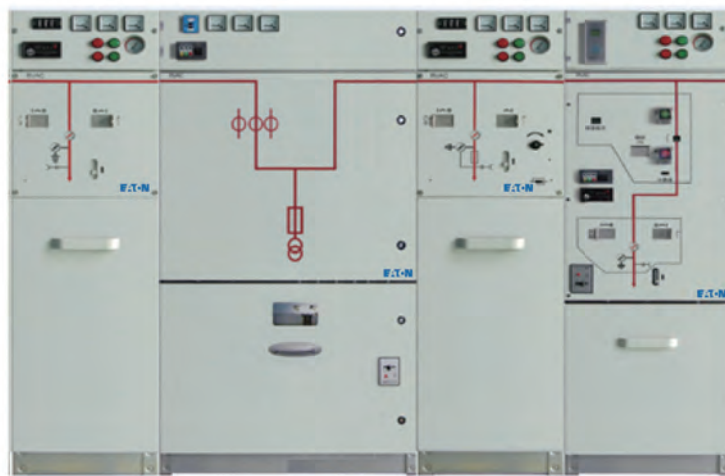

Size (mm)

A	B	C	D	E	F	G	H	I
800	730	683.5	800	750	520	470	82	8

Recommended Floor Plan

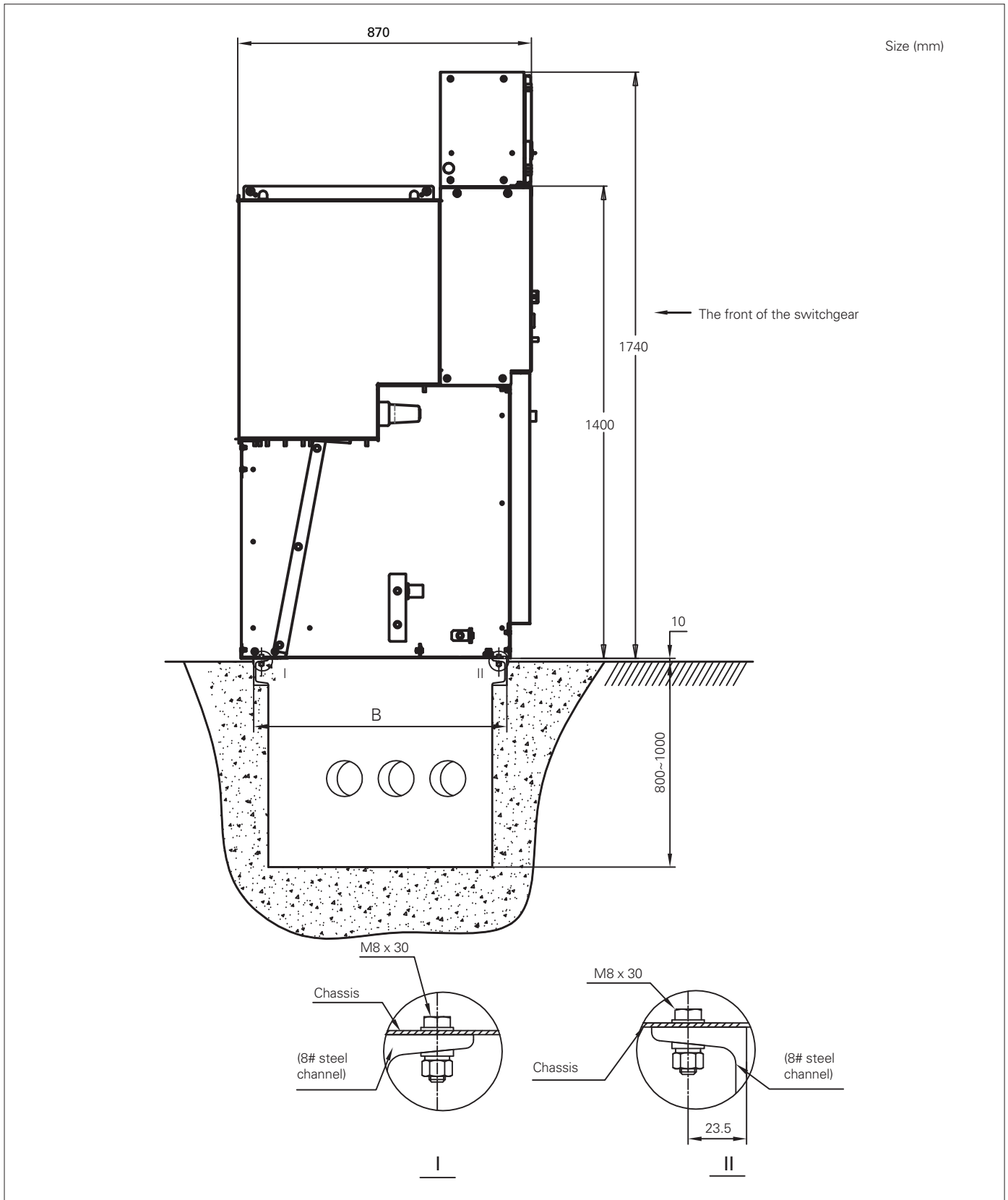

RVAC Series outdoor switching substation

Features for substation

Switching substation combined with indoor SF6 gas insulated RMU RVAC and outdoor enclosure.



- The enclosure material uses stainless steel or Zn-Al steel sheet with painting, the steel thickness is not less than 2mm, has the strong corrosion resistance; The loose parts are all metal sheet parts and are welded / riveted / bolted with each other to ensure the stable structure and light weight and elegant appearance.
- The top cover is a water-proof clival structure with ventilation outlet. The ventilation inlet is arranged in the lateral of enclosure with removable dust-proof filter net and the outlet is arranged at the top of the enclosure hidden under the eaves. It makes air convection from bottom to top.
- The cable inlets with sealed bottom plates are locked the bottom of outdoor enclosure to prevent moisture from cable channel into case body.
- The doors and lugs are sealed with sealing strips, the locks for doors is rainproof. The limiting hook is installed on the door to make door fix when the door is opened for maintenance.
- RMU inside enclosure is maintenance free design, which can adapt to the harsh outdoor environment.
- With the automatic terminal module(RTU) and remote control/ Monitoring Unit to facilitate the implementation of more extended functions.
- The outdoor enclosure's dimension and color will defined by project, the specific request may contact EATON beforehand.
- Key performance of outdoor switching sub-station :
 - Protection class: IP44 (IP54 optional)
 - Mechanical impact class: IK08
 - IAC: AFLR 20KA 1s

At Eaton, we make what matters work. Our energy-efficient solutions help customers effectively manage electrical, hydraulic and mechanical power more reliably, safely and sustainably. We are dedicated to improving the quality of life and the environment through the use of power management technologies and services. Eaton employs 100,000 people worldwide, and sells products to customers in more than 175 countries. Eaton generated sales of \$21.6 billion in 2018. For more information, visit Eaton.com.

Eaton began operation in China more than 20 years ago. Since entering the Chinese market in 1993, Eaton's presence has grown significantly in China. In 2004, Eaton moved its Asia Pacific headquarters from Hong Kong to Shanghai.

In Greater China region, we have approximately 10,000 employees, 29 manufacturing bases and 5 R&D centers. Today, we make most products for all of Eaton's distinct business here. Our energy-efficient products and solutions have helped our customers work more safely, efficiently and do business more sustainably.

For more information about Eaton China, visit: www.eaton.com.cn
Eaton China official social media account: Eaton_China

Cooper Edison (PDS) Power Systems Co.,Ltd
West of Science Building Xinhua Development
Area, Gaoyang Road Pingdingshan

Shanghai Cooper Power Capacitor Co., Ltd
Address: No. 955 Shengli Road, Zhangjiang
East High-Tech Zone, Shanghai China
Tel: 021-28993600
Fax: 021-28994254

Eaton Corporation
No.3, Lane 280, Linhong Road,
Changning District,
Shanghai, China 200335

Cooper Power Systems
No. 955 Shengli Road, Zhangjiang
East High-Tech Zone,
Shanghai, China 201201

© 2019 Eaton Corporation
All Rights Reserved
Printed in China
August 2019

Eaton is a registered trademark
of Eaton Corporation.

All trademarks are property of their
respective owners.